

1

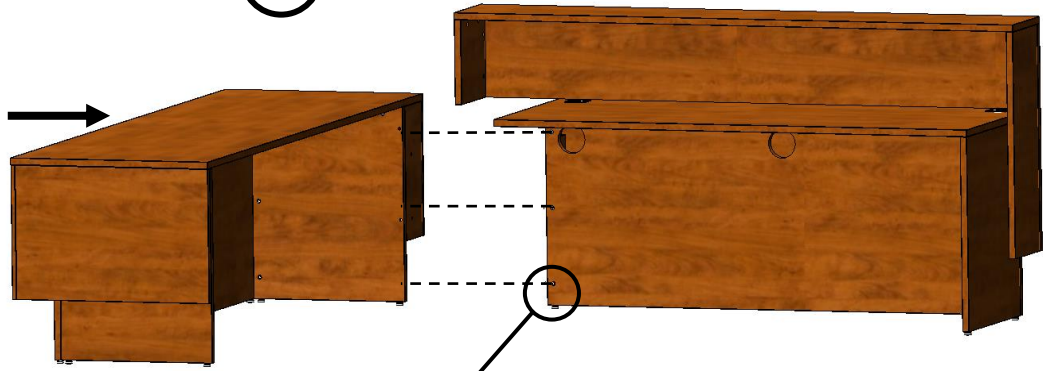

- 1) Engage parts as shown in the picture.
- 2) Turn Cam clockwise to lock the Pins.

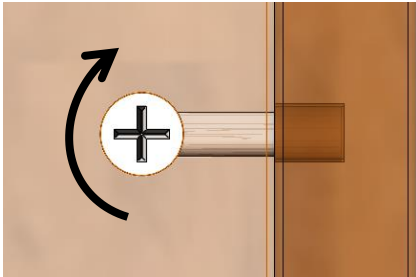
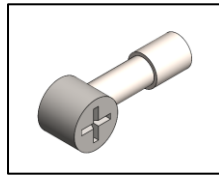

2

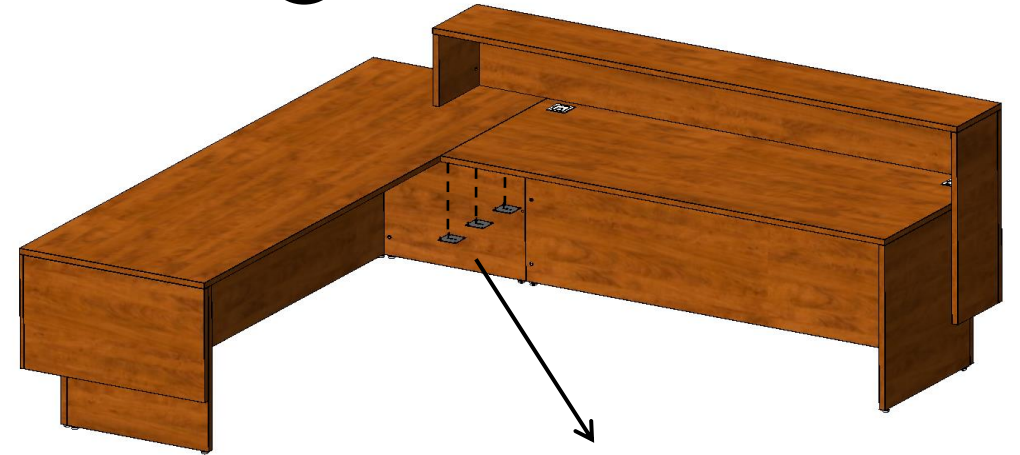

- 1) Attach connector bracket with the screws provided.

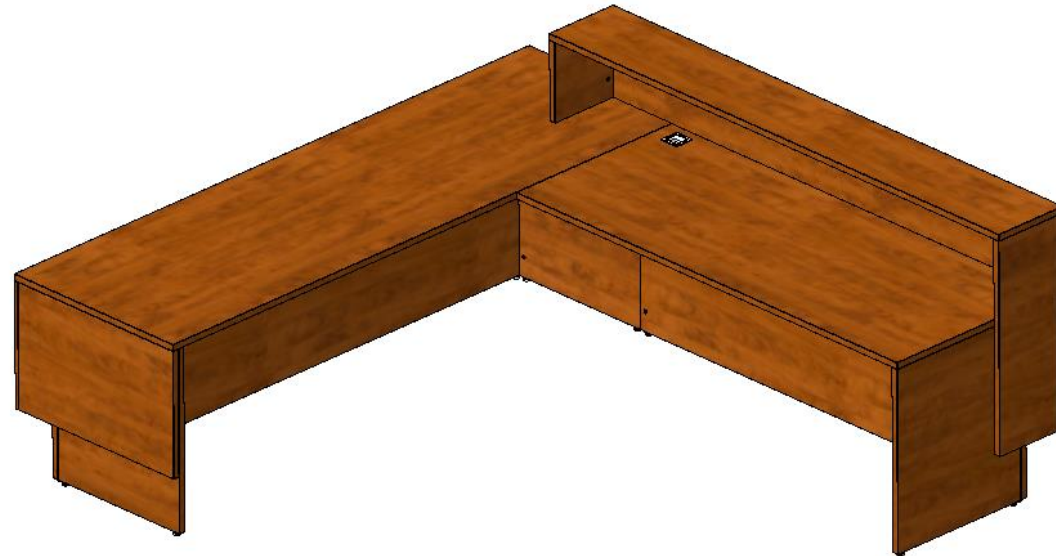

1

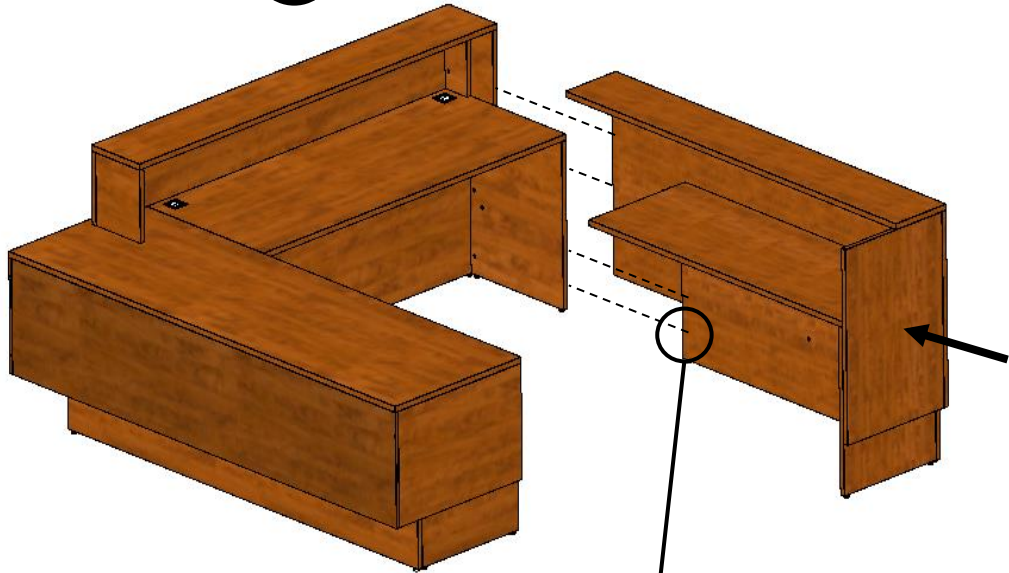

- 1) Engage parts as shown in the picture.
- 2) Turn Cam clockwise to lock the Pins.

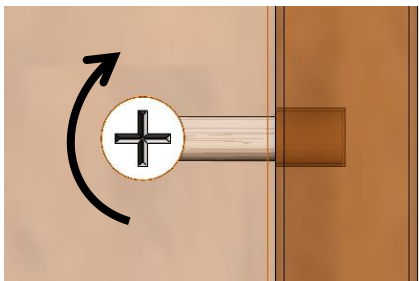
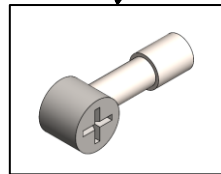

2

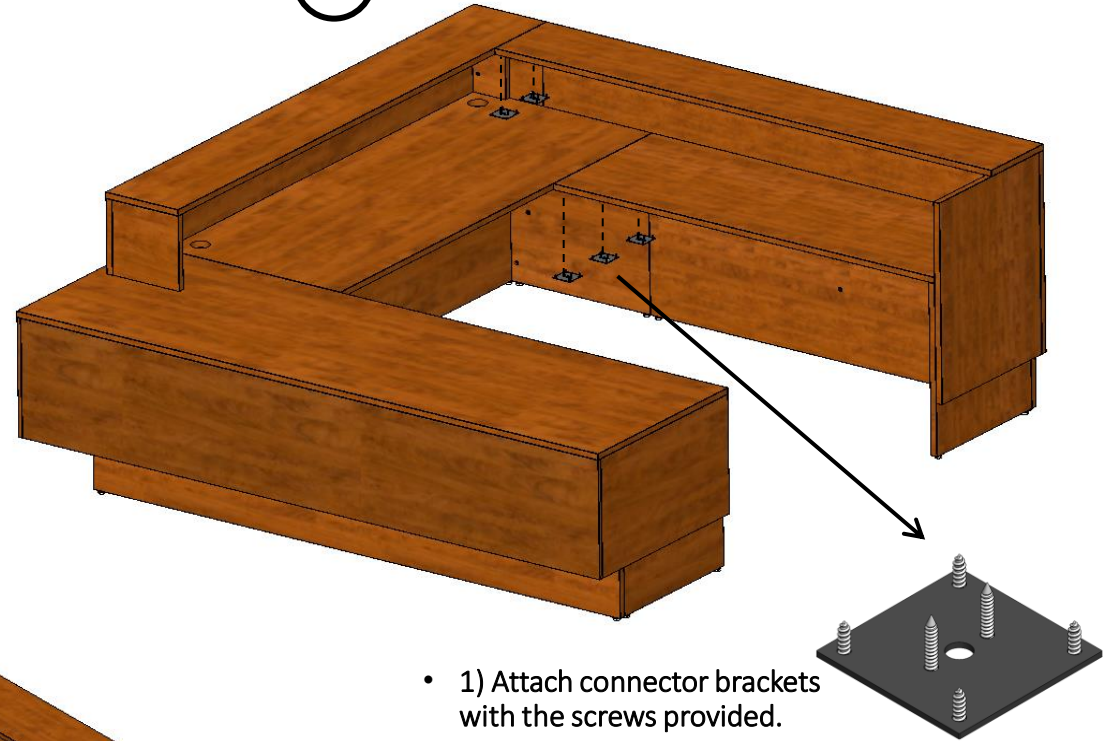

- 1) Attach connector brackets with the screws provided.